

CX4Storm

**Manuale di Istruzione
Instruction Manual
Mode d'Emploi
Manual de Instrucciones**

BRETTA

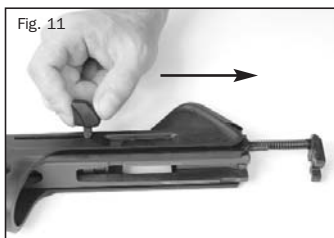

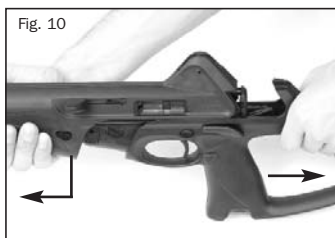
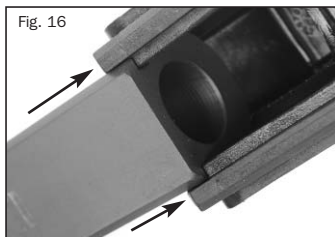



ENGLISH

**Illustrations on pages
2, 3, 54, 55, 170, 171**

ITALIANO

pagina 4

FRANÇAIS

page 86

ESPAÑOL

página 128

ALWAYS KEEP THIS MANUAL WITH YOUR FIREARM. INCLUDE IT WITH THE CARBINE WHEN IT CHANGES OWNERSHIP OR WHEN IT IS LOANED OR PRESENTED TO ANOTHER PERSON.

Notice: The Manufacturer and/or its Local Official Distributors assume no responsibility for product malfunction or for physical injury or property damage resulting in whole or in part from criminal or negligent use of the product, improper or careless handling, unauthorized modifications, use of defective, improper, hand-loaded, reloaded or remanufactured ammunition*, customer abuse or neglect of the product, or other influences beyond manufacturer's direct and immediate control.

* See paragraph "Ammunition".



WARNING: ALL FIREARMS HAVE LETHAL POTENTIAL. READ THE BASIC SAFETY RULES CAREFULLY AND UNDERSTAND THEM FULLY BEFORE ATTEMPTING TO USE THIS FIREARM.

In addition to the Basic Safety Rules, there are other Safety Rules pertaining to the loading, unloading, disassembly, assembly and use of this firearm, located throughout this manual.



WARNING: READ THE ENTIRE MANUAL CAREFULLY BEFORE USING THIS FIREARM. MAKE SURE THAT ANY PERSON USING OR HAVING ACCESS TO THIS FIREARM READS AND UNDERSTANDS ALL OF THIS MANUAL PRIOR TO USE OR ACCESS.

We recommend the use of original Beretta spare parts and accessories. The use of other manufacturer's spare parts and accessories could cause malfunctions and/or breakages that will not be covered by the Beretta Warranty.

CONTENTS

	Page
BASIC SAFETY RULES	48
NOMENCLATURE	54
DESCRIPTION	56
SAFETY FEATURES	56
OPERATIONAL AND ANATOMICAL FEATURES	58
SPECIFICATIONS	60
GENERAL OPERATION	61
LOAD CHECK	61
OBSTRUCTION CHECK	63
DISASSEMBLY	63
REASSEMBLY	65
AMMUNITION	66
LOADING AND FIRING	68
UNLOADING	71
ADJUSTING THE SIGHTS AND SIGHTING	72
FIRING	74
PICATINNY RAILS	77
MOUNTING THE STOCK SPACERS	77
REVERSING THE CONTROLS	79
MAINTENANCE	81
STORAGE	84

This instruction manual consisting of 171 pages.



BASIC SAFETY RULES



WARNING: PLEASE READ THIS MANUAL BEFORE HANDLING YOUR FIREARM.



WARNING: FIREARMS CAN BE DANGEROUS AND CAN POTENTIALLY CAUSE SERIOUS INJURY, DAMAGE TO PROPERTY OR DEATH, IF HANDLED IMPROPERLY. THE FOLLOWING SAFETY RULES ARE AN IMPORTANT REMINDER THAT FIREARM SAFETY IS YOUR RESPONSIBILITY.

1. NEVER POINT A FIREARM AT SOMETHING THAT IS NOT SAFE TO SHOOT.

Never let the muzzle of a firearm point at any part of your body or at another person. This is especially important when loading or unloading the firearm. When you are shooting at a target, know what is behind it. Some bullets can travel over a mile. If you miss your target or if the bullet penetrates the target, it is your responsibility to ensure that the shot does not cause unintended injury or damage.



2. ALWAYS TREAT A FIREARM AS IF IT WERE LOADED.

Never assume that a firearm is unloaded. **The only certain way to ensure that a firearm has the chamber(s) empty is to open the chamber and visually and physically examine the inside to see if a round is present.**

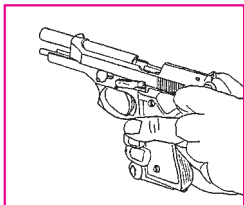

Removing or unloading the magazine will not guarantee that a firearm is unloaded or cannot fire. Shotguns and rifles can be checked by cycling or removing all rounds and by then opening and inspecting the chamber so that a visual inspection of the chamber for any remaining rounds can be made.

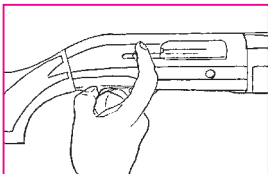
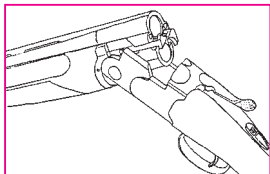

3. STORE YOUR FIREARM SO THAT CHILDREN CANNOT GAIN ACCESS TO IT.

It is your responsibility to ensure that children under the age of 18 or other unauthorized persons do not gain access to your firearm. **To reduce the risk of accidents involving children, unload your firearm, lock it and store the ammunition in a separate locked location.** Please note that devices intended to prevent accidents - for example, cable locks, chamber plugs, etc. - may not prevent use or misuse of your firearm by a determined person. Firearm storage in a steel gun safe may be more appropriate to reduce the likelihood of intentional misuse of a firearm by an unauthorized child or person.

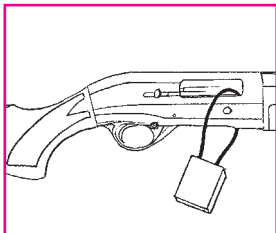
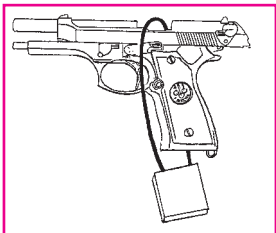



4. NEVER SHOOT AT WATER OR AT A HARD SURFACE.

Shooting at the surface of water or at a rock or other hard surface increases the chance of ricochets or fragmentation of the bullet or shot, which can result in the projectile striking an unintended or peripheral target.



5. KNOW THE SAFETY FEATURES OF THE FIREARM YOU ARE USING, BUT REMEMBER: SAFETY DEVICES ARE NOT A SUBSTITUTE FOR SAFE HANDLING PROCEDURES.

Never rely solely on a safety device to prevent an accident. It is imperative that you know and use the safety features of the particular firearm you are handling, but accidents can best be prevented by following the safe handling procedures described in these safety rules and elsewhere in the product manual. To further familiarize yourself with the proper use of this or other firearms, take a Firearms Safety Course taught by an expert in firearms use and safety procedures.

6. PROPERLY MAINTAIN YOUR FIREARM.

Store and carry your firearm so that dirt or lint does not accumulate in the working parts. Clean and oil your firearm, following the instructions provided in this manual, after each use to prevent corrosion, damage to the barrel or accumulation of impurities which can prevent use of the gun in an emergency. Always check the bore and chamber(s) prior to loading to ensure that they are clean and free from obstructions. **Firing with an obstruction in the barrel or chamber can rupture the barrel and injure you or others nearby.** In the event you hear an unusual noise when shooting, stop firing immediately, engage the manual safety and unload the firearm. Make sure the chamber and barrel



are free from any obstruction, like a bullet blocked inside the barrel due to defective or improper ammunition.

7. USE PROPER AMMUNITION.

Only use factory-loaded, new ammunition manufactured to industry specifications: CIP (Europe and elsewhere), SAAMI (U.S.A.). Be certain that each round you use is in the proper caliber or gauge and type for the particular firearm. The caliber or gauge of the firearm is clearly marked on the barrels of shotguns and on the slide or barrel of pistols. The use of reloaded or remanufactured ammunition can increase the likelihood of excessive cartridge pressures, case-head ruptures or other defects in the ammunition that can cause damage to your firearm and injury to yourself or others nearby.

8. ALWAYS WEAR PROTECTIVE GLASSES AND EARPLUGS WHEN SHOOTING.

The chance that gas, gunpowder or metal fragments will blow back and injure a shooter who is firing a gun is rare, but the injury that can be sustained in such circumstances can be severe, including the possible loss of eyesight. A shooter must always wear impact resistant shooting glasses when firing any firearm. Earplugs or other high-quality hearing protectors help reduce the chance of hearing damage from shooting.



9. NEVER CLIMB A TREE, FENCE OR OBSTRUCTION WITH A LOADED FIREARM.

Open and empty the chamber(s) of your firearm and engage the manual safety before climbing or descending a tree or before climbing a fence or jumping over a ditch or other obstruction. Never





pull or push a loaded firearm toward yourself or another person. Always unload a firearm, visually and physically check to see that the magazine, loading mechanism and chamber are unloaded, and action is open before handing it to another person. Never take a firearm from another person unless it is unloaded, visually and physically checked to confirm it is unloaded, and the action is open.

10. AVOID ALCOHOLIC BEVERAGES OR JUDGMENT / REFLEX IMPAIRING MEDICATION WHEN SHOOTING.

Do not drink and shoot. If you take medication that can impair motor reactions or judgment, do not handle a firearm while you are under the influence of the medication.



11. NEVER TRANSPORT A LOADED FIREARM.

Unload a firearm before putting it in a vehicle (chamber empty, magazine empty). Hunters and target shooters should load their firearm only at their destination, and only when they are ready to shoot. If you carry a firearm for self-protection, leaving the chamber unloaded can reduce the chance of an unintentional discharge.

12. LEAD WARNING.

Discharging firearms in poorly ventilated areas, cleaning firearms, or handling ammunition may result in exposure to lead and other substances known to cause birth defects, reproductive harm, and other serious physical injury. Have adequate ventilation at all times. Wash hands thoroughly after exposure.

It is YOUR responsibility to know and abide by Federal, State and Local laws governing the sale, transportation and use of firearms in your area.

Especially for U.S. consumers:

For information about Firearm Safety Courses in your area, please visit the National Rifle Association's web site at www.nra.org.

WARNING: This firearm has the capability of taking your life or the life of someone else! Always be extremely careful with your firearm. An accident is almost always the result of not following basic firearm safety rules.





NOMENCLATURE

- | | |
|----------------------------------|---|
| A Barrel | O Loaded chamber indicator |
| B Cocking handle | P Peep rearsight |
| C Manual safety button | Q Ejection port |
| D Bolt release lever | R Front sight |
| E Stock spacer | S Front rail |
| F Recoil pad | T Side rail seat |
| G Side sling swivel | U Magazine |
| H Rear sling swivel | V Stock (lower receiver) |
| I Magazine release button | Z Sight key |
| L Trigger | X Bolt assembly |
| M Disassembly latch | Y Receiver/barrel assembly
(upper receiver) |
| N Front sling swivel | |

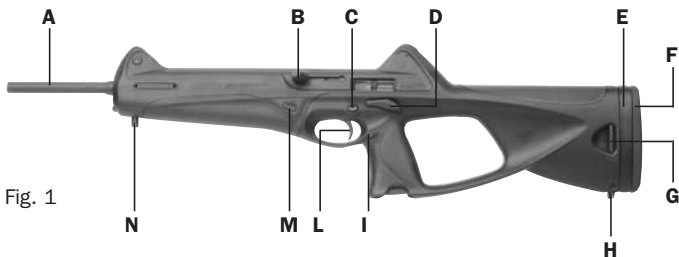

Fig. 1

Fig. 2

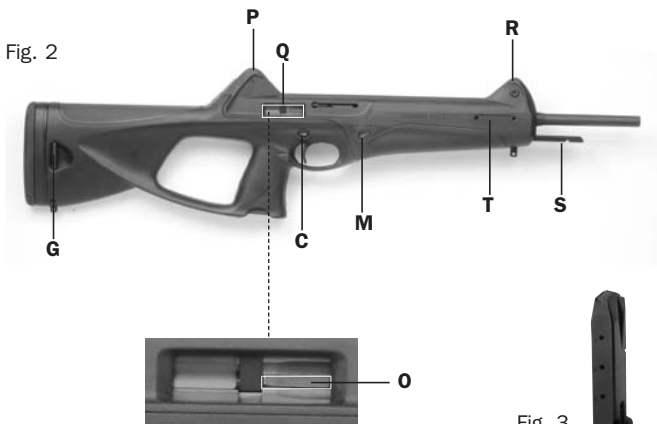

Fig. 3

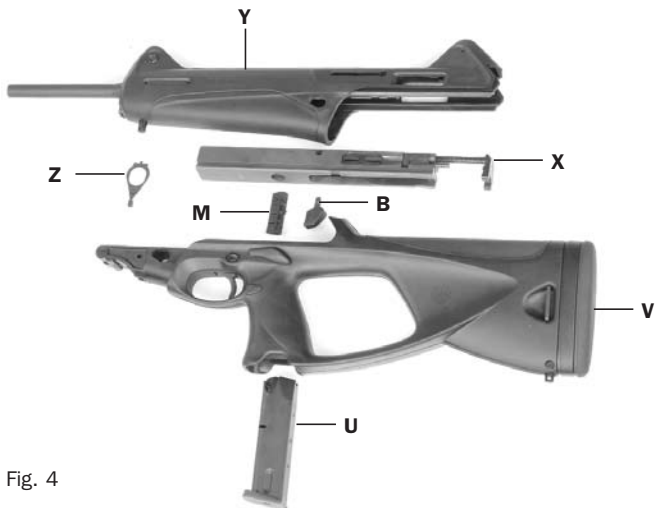

Fig. 4



DESCRIPTION

The Beretta Cx4 Storm semiautomatic carbine is a sporting or personal defense firearm with a particularly captivating appearance and simplicity of use. The blowback type locking system and the bolt safety ensure reliability, great stability and precision in follow up shots. The extractor, the ejector and the cocking handle are easily reversible for right and left hand use. The manual safety button and the magazine release button can also be reversed from one side of the carbine to the other*.

The cold hammer forged barrel is chrome lined and made of high resistance steel for maximum resistance to corrosion and increased barrel life.

Extensive use of technopolymers has allowed the development of a light and technically advanced firearm as well as equipping it with very modern and ergonomic lines.

Rounded forms are snag free, facilitating handling and rapid shouldering and aiming.

* This operation should be carried out by a gunsmith

SAFETY FEATURES

Notice: The figure numbers noted below refer to the photographs on pages 2, 3, 54, 55, 170, 171.

Manual safety button (reversible) (Fig.1/2 - C). The Cx4 Storm features a manual safety that blocks the trigger. The manual safety can be engaged when the hammer is in the decocked or cocked position, or when the bolt is open or closed. The manual safety button is reversible for right or left hand use.

Automatic Firing Pin Block. The Cx4 Storm has a blocking device that prevents forward movement of the firing pin unless the trigger is pulled. This feature is intended to prevent discharge if the carbine is dropped or if the hammer is unintentionally dropped without pulling the trigger.

Loaded chamber indicator (Fig. 2-0). The loaded chamber indicator is a small tab that protrudes from the bolt when a round is in the chamber. The tab is located on the ejector of the carbine and can be both seen and felt, allowing the user to check the chamber for the increased protrusion of the tab. **Please note:** The most certain way to check whether a carbine is loaded is to pull back on the bolt and visually inspect the chamber for a round. Loaded chamber indicators are designed primarily to allow noiseless inspection of the carbine to ensure that it is loaded in situations when it may be dangerous to operate the bolt (the action of pulling back on the bolt may make noise and will temporarily render the carbine inoperable) or when it is dark. The loaded chamber indicator is reversible for right or left hand use.

WARNING: In order to permit the use of the Cx4 Storm in emergency situations, even in the case of involuntary dropping or loss of the magazine, these models are NOT provided with a magazine safety. They are therefore capable of firing, if a round is chambered, even if the magazine has not been inserted or if it has been removed or if it has been dislodged from its seat.

Bolt release lever (Fig. 1-D). The bolt release lever allows the closing of the bolt which remains in the open position after the last round from the magazine has been fired (magazine inserted). This permits the user to immediately determine that the carbine does not have a round in the chamber or in the magazine.

Bolt travel stop. This safety system is an inertia device which avoids the complete opening of the bolt in case the carbine is dropped, preventing the accidental introduction of the round into the chamber or the ejection of the chambered cartridge.

Safety on the hammer. The hammer features a device that prevents the disengaging of the hammer itself. This safety is intended to reduce the possibility of discharge of the carbine if it is dropped.





OPERATIONAL AND ANATOMICAL FEATURES

Semiautomatic firing. The Cx4 Storm carbine will automatically reload after each round is fired, as long as there are cartridges in the magazine.

The blowback type locking system and the bolt safety ensure reliability, great stability and precision in follow up shots.

Single action. The short and light single action trigger pull allows for faster, more accurate discharge of subsequent rounds.

Removable magazine (Fig. 3). The Beretta Cx4 Storm carbine has a quickly removable, high capacity magazine which allows rapid reloading and extended use in emergency situations.

The capacity of magazine for Cx4 Storm models is as follows*:

cal. 9mm Parabellum** – 10,15, 20 rounds, staggered magazine

cal. 9mm x 21 IMI - 10, 15 rounds, staggered magazine

cal. 40 S&W*- 10, 11 rounds, staggered magazine

cal. 45 ACP (Auto) – 8 rounds, staggered magazine

* Consult local authorities for maximum magazine capacity restrictions that may apply in your locale.

** Commercial carbines sold in the US market are supplied with 10-round magazines in accordance with US Federal Guidelines for Commercial Sales.

Specific calibers, may not be available in you market.

Where permitted by law the Cx4 Storm is able to utilize the same magazines as the 92/96/98 and 8000/8040/8045 Cougar pistol series through the assembly of an adapter in the magazine seat.

Reversible controls. The extractor, the ejector, the cocking handle, the ejection port cover, the magazine release button and the manual safety button are reversible for right or left hand use.

Simple field stripping and cleaning (Fig. 1/2-M). The disassembly mechanism consists of a latch found below the cocking handle. It is designed to allow an extremely quick and simple field stripping of the carbine and also to avoid casual or involuntary disassembly. A firearm which can be easily field stripped can be more readily cleaned. Simple cleaning makes it easier for the user to properly maintain your carbine, which helps ensure continued reliability.

Technopolymer frame. (Fig. 4-V/Y). The extensive use of technopolymers has allowed the development of a light and technically advanced firearm as well as equipping it with very modern, extremely captivating and ergonomic lines. The technopolymer also guarantees corrosion resistance and color consistency (the color will never wear or scratch off).

Sights (Fig. 2-P/R). The front sight is fully adjustable for windage and elevation while the peep rearsight has long and short range apertures. Both sights may be folded down when optics are used.

Adjustable stock (Fig. 1-E). Special stock spacers (up to three) allow the lengthening of the stock. Each spacer increases the length of the stock by 15 mm (0.60 in.). A spacer is already supplied (mounted on the stock) with your Beretta Cx4 Storm carbine.

Picatinny rails. In addition to the standard extractable Picatinny type rail found underneath the barrel and the side rail supplied in the case, top and bottom Picatinny rails are also available on request.

Swivels for carrying sling (Fig. 1-N/H). On the front and rear part of the stock, swivels are mounted for the optional carrying sling. The rear part of the stock features a side, vertical slot type swivel. (Fig. 1/2-G).

NOTICE: There are numerous Beretta special parts and accessories that allow the personalization of your carbine. To request this extensive line of parts and accessories, please contact your local Beretta dealer.



SPECIFICATIONS

<i>Caliber</i>	9mmx19 (Parabellum or Luger)	9mmx21 IMI	40 S&W	45 ACP (Auto)
<i>Magazine capacity (rounds)*</i>	10, 15, 20	10, 15	10, 11	8
<i>Pitch</i>	250 mm	250 mm	400 mm	406 mm
<i>Rifling</i>	R.H., 6 grooves			
<i>Operation</i>	Semiautomatic, it fires from the closed bolt position.			
<i>Locking system</i>	Blowback type			
<i>Action</i>	Single action only			
<i>Sights</i>	Fully adjustable front sight for windage and elevation, foldable. 2-position peep rearsight, foldable.			
<i>Safeties</i>	Manual safety on the frame: it can be applied with hammer cocked or decocked, bolt open or closed. Automatic firing pin blocking device. Bolt travel stop. Safety on the hammer.			
<i>Frame/Receiver</i>	In technopolymer			
<i>Bolt</i>	In steel			
<i>Barrel</i>	In steel, cold hammer forged, chrome lined.			
<i>Overall length</i>	(mm/in)	755/29.7 - 800/31.5 with 0 to 3 stock spacers		
<i>Barrel length</i>	(mm/in)	422.5/16.6		
<i>Overall width</i>	(mm/in)	63/2.5		
<i>Overall height</i>	(mm/in)	190/7.5		
<i>Sight radius</i>	(mm/in)	327/12.9		
<i>Weight unloaded (without magazine)</i>	(gr/oz)	(approx.) 2575/90.8		

* Commercial carbines sold in the US market are supplied with 10-round magazines in accordance with US Federal Guidelines for Commercial Sales.

GENERAL OPERATION

The Beretta Cx4 Storm is a semiautomatic blowback type firearm. Upon firing, the pressure developed by the combustion gases pushes the bolt back which, during its rearward movement, extracts and ejects the fired cartridge case, cocks the hammer and compresses the recoil spring. The bolt will then automatically move forward towards the closed position, feeding the next cartridge from the magazine into the chamber. The bolt is designed to stay open after the last round has been fired and ejected.

LOAD CHECK

At various points in this manual you will be instructed to “visually check to be certain your Beretta Cx4 Storm carbine is unloaded.” This should become second nature to you, as you should:

- Never assume that a firearm is unloaded (even a gun that is new and in its original packaging).
- Never point or push a firearm toward yourself or another person.
- Always visually check to see that the chamber is unloaded.
- Remove the magazine, engage the manual safety and block the bolt in the open position before handing the carbine to another person.
- Never take or pull this carbine from another person unless the safety is engaged, the magazine is removed, the bolt is open, and the chamber has been visually checked to confirm it is unloaded.

To visually check to be certain your Beretta Cx4 Storm carbine is unloaded, carefully follow the steps below.

WARNING: Keep your finger OFF THE TRIGGER and the barrel pointed in a SAFE direction.





- Engage the manual safety by pushing the manual safety button until the red band completely disappears. **(Fig. 5)**



WARNING: When the safety button shows the red band, the safety is disengaged and the firearm is in the FIRE position.

- Remove the magazine by pushing the magazine release button. **(Fig. 6)**

- Retract the cocking handle to open the bolt **(Fig. 7)** (Releasing the bolt when a magazine is not in the carbine will automatically close the bolt). Always keep your finger away from the ejection port. To keep the bolt in the open position, without the magazine in the carbine, press the bolt release lever upwards with your thumb **(Fig. 8)** and release the cocking handle. The bolt will be blocked in the open position.

The bolt remains open when an empty magazine is inserted or when the bolt release lever is pressed upwards.

- Check the cartridge chamber to be certain it is empty.

If the carbine is unloaded, proceed to the following step, otherwise refer to the procedure: Unloading the carbine.

- Holding the cocking handle, press the bolt release lever downwards with your thumb and gently take the bolt to the closed position.



WARNING: Always keep your finger away from the ejection port.



WARNING: THE HAMMER IS COCKED. With the barrel pointed in a safe direction, decock the hammer by pulling the trigger.

Notice: The hammer can be decocked only when the bolt is in the closed position.

OBSTRUCTION CHECK

Check the barrel to be sure there are no obstructions in the chamber and bore. This is extremely important because if another cartridge is fired into an obstructed barrel, a catastrophic failure can result.

To visually check to be sure there are no obstructions in the barrel, follow the disassembly steps below:

DISASSEMBLY

WARNING: Always be certain that the carbine is unloaded. Please refer to the instructions given in the "load check" paragraph.

Notice: It is advisable to carry out the field stripping operations over a table to catch components should they drop.

CAUTION: Before disassembling the parts, carefully observe and memorize the position of the components to facilitate their correct reassembly.

- Remove the magazine by pushing the magazine release button. **(Fig. 6)**
- To facilitate disassembly, it is advisable to cock the hammer. Retract the bolt by means of the cocking handle and gently take the bolt to the closed position. **(Fig. 7)**

WARNING: By retracting the cocking handle when an empty magazine is inserted in the carbine, the bolt remains in the open position. To close the bolt press the bolt release lever downwards. Always keep your fingers away from the ejection port.

- Push the disassembly latch out the frame of the carbine. **(Fig. 9)** The disassembly latch can be removed from either side.





- Slide the front part of the carbine (receiver/barrel assembly) from the stock. **(Fig. 10)**
- Fully retract the cocking handle until it corresponds with the opening (circular part) of the port. **(Fig. 11)**
- Remove the cocking handle by pulling it forcefully. **(Fig. 12)**

WARNING: At this stage, the bolt is not blocked into position by the cocking handle and could therefore fall out. Handle with care all disassembled parts.

- Remove the bolt from the barrel. **(Fig. 13)**

Look down the barrel from the muzzle (or front) end so that you can see completely through the barrel to make sure no obstruction exists.

If an obstruction in the barrel is detected, a qualified gunsmith must remove the obstruction and inspect the carbine before it can be fired.

WARNING: If another cartridge is fired into an obstructed barrel, a catastrophic failure can result.

REASSEMBLY

- Check that the hammer is cocked. If not, completely pull the trigger and keep it depressed, draw back the hammer and release the trigger. The hammer will be blocked in the cocked position (fully retracted). **(Fig. 14 and 15)**
- Reassemble the bolt on the barrel corresponding the lower guides of the bolt with the lower guides of the receiver. **(Fig. 16)**
- Line up the hole found on the bolt body with the rear part of the cocking port (circular part). **(Fig. 12)**
- Insert the cocking handle (with the concave part facing the barrel) into the seat pushing it into the hole of the bolt.
- Push the cocking handle completely forwards until it stops.
- Reassemble the stock by engaging the side rails of this last part with the side rails of the receiver/barrel/bolt assembly. **(Fig. 17)**
- Slide the receiver/barrel/bolt assembly onto the stock until it stops.
- Insert and push the disassembly latch in the seat while holding the stock and receiver/barrel/bolt assembly together.
- Pull the trigger to decock the hammer.



AMMUNITION

AMMUNITION (CARTRIDGE) NOTICE: Beretta specifically disclaims responsibility for any damage or injury whatsoever occurring in connection with, or as the result of, the use in Beretta Cx4 Storm carbine of faulty, or non-standard, or “remanufactured,” or hand-loaded (reloaded) ammunition, or cartridges other than those for which the firearm was originally chambered.

Use only high-quality, commercially-manufactured ammunition that is manufactured in accordance with CIP (Europe and elsewhere) or SAAMI (USA) standards. Be certain that the ammunition is the appropriate caliber and loading for the firearm and is clean, dry, and in good condition. The cartridge designation for your carbine is marked on the side of the barrel and in front of the cocking handle (visible when drawn back).



WARNING: Carefully inspect each cartridge before it is loaded in the magazine. Be certain the cartridge cases are not split, deformed, or the cartridges do not possess any other dents or defects (this applies even to factory ammunition).

Do not fire old ammunition in this firearm. Primers, powder, cartridge cases, and bullets can deteriorate with time and cause damage to the firearm, or injury to the shooter or others.



WARNING: Do not use reloaded or handloaded ammunition. Beretta assumes no liability for incidents occurring through the use of reloaded ammunition. Use of reloaded ammunition will void the manufacturer’s warranty.



WARNING: The extended use of +P, +P+ ammunition may decrease the minor components service life expectancy. DO NOT use sub-machine gun ammunition because the chamber pressure may reach or exceed proof load pressure.

Lead bullets have a tendency to cause bore leading, which may dramatically increase the discharge pressure.

Make sure to remove all chamber and bore lead accumulation after each use.

DO NOT ever shoot cartridges with jacketed bullets through a barrel previously fired with lead bullets before the bore is thoroughly delead.

DRY FIRING/"DUMMY" ROUNDS

Dry firing is defined as firing a firearm with no ammunition in the chamber. Long term dry firing your Beretta Cx4 Storm carbine may result in damage to the action. "Snap caps" (inert chamber inserts that allow a firearm to be dry-fired without damaging the action) are available at most gun stores for those who wish to practice firing without live ammunition.

CAUTION: If you want to practice shooting your carbine without using live ammunition (called "dry firing"), insert an appropriate "snap cap" into the chamber to cushion the fall of the firing pin and reduce the chance of firing pin breakage. "Snap cap" cartridges with spring loaded "primers" are ideal. "DUMMY" cartridges with empty primer pockets are good for loading/unloading practice but DO NOT protect the firing pin during dry firing.



LOADING AND FIRING

Notice: The figure numbers noted below refer to the photographs on pages 2, 3, 54, 55, 170, 171.



WARNING: Beretta assumes no responsibility for any injury or property damage resulting from improper or careless handling, intentional or accidental discharge of the firearm.



WARNING: This carbine can have a live round in the chamber and can fire even if the magazine is empty or has been removed.



WARNING: Before loading the firearm, become familiar with the following loading procedures without the use of ammunition. Never handle a loaded firearm until you are fully familiar with the loading procedures. Always point the firearm in a safe direction.



WARNING: Always keep your finger away from the trigger whenever you do not intend to fire.

Make sure the carbine is not already loaded by removing the magazine and retracting the bolt in order to check that the chamber is empty.



WARNING: Be sure that you have the correct cartridges for your carbine.



WARNING: Be sure that the obstruction check has been completed prior to loading.

CAUTION: Always wear protective glasses and earplugs when shooting (See point 8 of the BASIC SAFETY RULES).

LOADING THE MAGAZINE

- To load the magazine, remove it from the carbine by pushing the magazine release button. **(Fig. 6)**
- Hold the magazine in one hand. With the other hand place a cartridge on the magazine follower in front of the lips at the top of the magazine. Press the cartridge down onto the follower

and slide the cartridge completely under the lips until it is lodged fully inside the magazine body. **(Fig. 18)**

- Repeat process until magazine is fully loaded. Holes on the back of the magazine allow for visual counting of cartridges. **(Fig. 3)**

CAUTION: Do not try to force more than the maximum number of rounds indicated for your particular carbine into the magazine. An overloaded magazine may not function properly.

LOADING THE CARBINE AND THE FIRING CHAMBER

WARNING: Point the firearm in a safe direction. Do not touch the trigger until you are ready to shoot and are sure of your target and backstop.

The firing chamber of the carbine is the portion of the barrel into which the cartridge is fed. The firing chamber may be loaded in one of two ways:

1. LOADING FROM MAGAZINE

- Engage the manual safety by pushing the manual safety button until the red band disappears. **(Fig. 5)**

WARNING: When the safety button shows the red band, the safety is disengaged and the firearm is in the FIRE position.

WARNING: The manual safety is merely a mechanical device and is in no way a substitute for the Basic Safety Rules of firearm handling.

- Completely push the loaded magazine into the carbine grip to ensure catch engagement.
- Pull back the bolt and release it. The bolt will automatically pick up a cartridge from the top of the magazine and feed it into the chamber.

WARNING: THE CARBINE IS NOW CHAMBER LOADED, COCKED AND READY TO FIRE BY PULLING THE TRIGGER. Keep your finger away from the trigger whenever you do not intend to fire.



2. THIS CARBINE WHICH IS LOADED AND FIRED WILL AUTOMATICALLY PICK UP THE NEXT ROUND AND FEED IT INTO THE FIRING CHAMBER AS LONG AS THERE IS AMMUNITION IN THE MAGAZINE.

Notice: The manufacturer assumes no responsibility for any injury or property damage resulting from improper or careless handling, intentional or accidental discharge of the firearm.

Notice: The Beretta Cx4 Storm carbine is equipped with an automatic safety which prevents firing pin protrusion beyond the breech face. This safety is overcome only by trigger pull.

If you want to replace the round which has been chambered from the magazine (remember that you are handling a loaded firearm with a live round in the chamber):

- Check the manual safety is engaged.
- Remove the magazine from the carbine by pushing the magazine release button.
- Insert one more cartridge into the magazine.
- Completely push the loaded magazine into the carbine grip to ensure catch engagement.

WARNING: REMEMBER THAT YOU ARE HANDLING A LOADED FIREARM, WITH A LIVE ROUND IN THE CHAMBER. Keep your finger away from the trigger whenever you do not intend to fire.

UNLOADING

WARNING: Be certain the carbine is pointed in a SAFE direction.

WARNING: Do not place your finger on the trigger or inside the trigger guard.

- Engage the manual safety (**Fig. 5**).
- Pointing the firearm in safe direction, remove the loaded magazine from the grip.
- Fully retract the bolt by means of the cocking handle to remove the chambered cartridge.

WARNING: Always visually inspect the firing chamber to ensure that it is empty. The chamber is empty when no cartridge is visible when looking into the open chamber.

WARNING: If you are ejecting unfired cartridges, use extreme care to be sure they are ejected onto an appropriate surface. Never attempt to catch cartridges or fired cartridge cases as they fall.

WARNING: Never allow anything to come in contact with the primer of unfired ammunition. Doing so could cause the ammunition to explode.

- When sure that the chamber is empty and the cartridge has been ejected, release the bolt.

WARNING: Depressing the slide release lever when a loaded magazine is in the carbine will feed a cartridge into the carbine's firing chamber. Having the hammer cocked, the carbine will be in the condition of being able to fire immediately.

To increase the service life of the hammer spring, it is advisable to decock the hammer by pulling the trigger.

WARNING: Always unload the firearm immediately after shooting is completed.





UNLOADING THE MAGAZINE

- To unload the magazine, grasp it with one hand around the magazine box, bottom down and front end forward. With the tip of the thumb firmly press down on the cartridge rim and push towards the front of magazine box. As the cartridge moves forward, tip it slightly upward with the index finger.
- Repeat until the magazine is unloaded.

ADJUSTING THE SIGHTS AND SIGHTING

WARNING: Always be certain that the carbine is unloaded before adjusting the sights. Please refer to the instructions given in the "Load check" paragraph.

WARNING: Make sure the carbine is pointed in a safe direction.

The Beretta Cx4 Storm features a fully adjustable front sight for elevation and windage and an adjustable peep rearsight for long and short range distances. Both sights may be folded down when optics are used.

The upper part of the carbine is designed to accept the mounting of optional Picatinny rails for the application of scopes and aiming systems on request.

FRONT SIGHT – WINDAGE ADJUSTMENT

To move the point of impact to the right:

Using the supplied tool (**Fig. 4-Z**) loosen the screw on the right of the front sight (as viewed from the rear) clockwise in the direction of the arrow (R= right). Proceed one click at a time. (**Fig. 19**)

To move the point of impact to the left:

Using the supplied tool (**Fig. 4-Z**) loosen the screw on the right of the front sight (as viewed from the rear) counterclockwise in the opposite direction of the arrow. Proceed one click at a time. (**Fig. 19**)

Notice: It is recommended to hold the front sight during the adjustment in windage to avoid the front sight folding during the loosening of the screw.

FRONT SIGHT - ELEVATION ADJUSTMENT

To raise the point of impact:

Using the supplied tool (**Fig. 4-Z**) loosen the front sight clockwise. Proceed one click at a time. (**Fig. 20**)

To lower the point of impact:

Using the supplied tool (**Fig. 4-Z**) loosen the front sight counterclockwise. Proceed one click at a time. (**Fig. 20**)

To fold the front sight, rotate it downwards.

PEEP REARSIGHT

For long range shooting, vertically position the rearsight leaf with the letters LR (Long Range) with your finger. For short range shooting, rotate the LR leaf downwards to raise the rearsight leaf with the letters SR (Short Range).

To completely fold the rearsight leaves, rotate them down towards the barrel.

SIGHTING

Point the carbine at the target you intend to shoot and aim by focusing the front sight through the hole of the rearsight leaf. Place the front sight on your target. The front sight should be in focus while the target slightly blurred or out of focus.



FIRING



WARNING: Only point a firearm at something safe to shoot. Never put your finger on the trigger unless you intend to shoot. Never disengage the safety on a firearm unless you intend to shoot.



WARNING: Always wear high-quality eye and ear protection when firing any firearm. Be certain that others near-by are wearing high-quality eye and ear protection and are to the rear of the shooter, when firing any firearm.

WHEN READY TO FIRE:

- Load the firearm using the loading procedures above.
- Point the carbine at the intended target.
- Release the manual safety by simply pushing the manual safety button until the red band appears.



WARNING: When the red band on the manual safety button is exposed, indicates that the safety is off and the firearm is ready to FIRE!

- When the sights are aligned on a SAFE target, place your index finger inside the trigger guard and gently squeeze the trigger, being careful not to upset the alignment of the front sight and the target. **THE CARBINE WILL FIRE.**

The discharge will cause the bolt to recoil which, in turn, will eject the fired cartridge case, cock the hammer and compress the recoil spring. Then the bolt will automatically close, feeding the next cartridge from the magazine into the chamber.

- After the first shot is fired, repeat this process to fire additional cartridges, or proceed to the unloading instructions.



WARNING: THE CARBINE IS STILL CHAMBER LOADED, COCKED AND READY TO FIRE AGAIN. Keep your finger away from the trigger whenever you do not intend to fire and immediately engage the manual safety.

- When the last round has been fired the bolt remains open.

If you have completed shooting, engage the manual safety, remove the magazine and holding the cocking handle, press the bolt release lever downwards with your thumb and gently take the bolt to the closed position. Pull the trigger to decock the hammer.

- To fire again, remove the empty magazine and insert a loaded one.
- If the bolt is in the open position press the bolt release lever downwards to insert the round in the chamber. If the bolt has been closed, retract it by means of the cocking handle and immediately release the bolt to insert the cartridge in the chamber.

WARNING: THE CARBINE IS NOW CHAMBER LOADED, COCKED AND READY TO FIRE AGAIN. Keep your finger away from the trigger whenever you do not intend to fire and immediately engage the manual safety.

WARNING: Always unload the firearm immediately after shooting is completed. Never store a loaded firearm. To store the carbine see the dedicated paragraph (Storing).

If while firing the trigger is pulled and the firearm does not immediately fire:

CEASE FIRING IMMEDIATELY!

- Keep the firearm pointed in a SAFE direction in the event a “hang-fire” has occurred. A hang-fire occurs when there is a delay in a cartridge’s ignition.
- With the carbine pointed in a SAFE direction, wait one (1) full minute.
- After one (1) full minute has elapsed, completely unload the firearm by following the unloading instructions in this manual.
- Carefully inspect your ammunition.
- Immediately refer to a qualified gunsmith if the firing pin indent on a fired cartridge’s primer is light, off-center or does not exist.





- Using the disassembly instructions in the beginning of this manual under Obstruction Check, remove the frame-barrel/bolt assembly from the stock and visually check to be sure there are no obstructions in the barrel. If a barrel obstruction is detected, a qualified gunsmith must remove the obstruction and inspect the carbine before it can be fired.



WARNING: If another cartridge is fired into an obstructed barrel, a catastrophic failure can result.



WARNING: Never attempt to fire ammunition that did not fire the first time.

If, while firing, you hear a change in the sound a fired cartridge makes, or feel a change in the amount of recoil of a fired cartridge, or detect any other irregularity:

CEASE FIRING IMMEDIATELY!

- Keep the firearm pointed in a SAFE direction. A “squib load” may have occurred. A “squib” occurs when a cartridge fires, but with insufficient force to drive the bullet out of the barrel. This can result in a dangerous bore obstruction.



WARNING: If another cartridge is fired into an obstructed barrel, a catastrophic failure can result.

- With the gun pointed in a SAFE direction, completely unload the firearm by following the unloading instructions in this manual.
- Using the disassembly instructions remove the frame-barrel/bolt assembly from the stock and visually check to be sure there are no obstructions in the barrel. If a barrel obstruction is detected, a qualified gunsmith must remove the obstruction and inspect the carbine before it can be fired.
- Carefully inspect your ammunition.



WARNING: Never attempt to reuse or fire ammunition that did not fire the first time. Dispose of unfired or damaged ammunition properly, per the ammunition manufacturer’s recommendation.



WARNING: Always unload the firearm immediately after shooting is completed. Never store a loaded firearm. To store the firearm see the dedicated paragraph (Storing).

PICATINNY RAILS

WARNING: Always be certain that the carbine is unloaded. Please refer to the instructions given in the "Load check" paragraph.

WARNING: Make sure the carbine is pointed in a safe direction.

Under the barrel, inside the fore-end of the upper receiver, the standard Picatinny type rail supplied with your carbine can be extracted. (**Fig. 2-S**) To do so, push the front sling swivel and simultaneously extract the internal rail (**Fig. 21**).

To mount the side Picatinny type rail included with your carbine, it is sufficient to attach it with the two screws supplied into their respective seats. (**Fig. 2-T**) The rail can be mounted on both sides of the receiver (**Fig. 22**). Other optional Picatinny rails to mount on the top of the frame (MIL-STD-1913) (**Fig. 23**) and under the barrel (**Fig. 24**) are available on request.

MOUNTING THE STOCK SPACERS

WARNING: Always be certain that the carbine is unloaded. Please refer to the instructions given in the "Load check" paragraph.

WARNING: Make sure the carbine is pointed in a safe direction.

Notice: It is advisable to disassemble the stock from the receiver/barrel/bolt assembly (see paragraph regarding disassembly).

If you wish to mount additional spacers (available on request) on the stock in order to increase the length or to remove the one already mounted in order to decrease the length of the stock, proceed as follows:





- Remove the rubber recoil pad from the rear of the stock (**Fig. 25**).
- Unscrew in a counter clockwise direction the rear screw from the stock with a 7 mm blade screwdriver (**Fig. 26**).
- Completely remove the screw.
- Remove the mounted spacer if you wish to shorten the stock or add more spacers (available on request) to lengthen the stock.

CAUTION: once the screw has been removed from the stock, the rear sling swivel (**Fig.1/2-G**) is not fixed to the stock. Take care not to lose it.

- To remount the screw make sure to correctly centre the screw with the respective seat of the sling swivel.
- Using the screwdriver, completely screw and tighten the screw in a clockwise direction on the stock.
- Reassemble the rubber recoil pad.

REVERSING THE CONTROLS

WARNING: Always be certain that the carbine is unloaded. Please refer to the instructions given in the "Load check" paragraph.

WARNING: Make sure the carbine is pointed in a safe direction.

EXTRACTION, EJECTION AND COCKING HANDLE

Notice: It is advisable to carry out the field stripping and the assembly operations over a table to catch components should they drop.

CAUTION: Before disassembling the parts, carefully observe and memorize the position of the components to facilitate their correct reassembly.

- Disassemble the bolt from the barrel sliding it from the receiver (See paragraph on disassembly).
- Remove the retaining spring clip from the spring/spring guide assembly (**Fig. 27**). The operation can be facilitated by levering the spring/spring guide upwards.
- Remove the ejector from its seat (**Fig. 28**).
- On the opposite side, remove the extractor (**Fig. 29**).

CAUTION: In order to invert the ejection from one side to the other, it is necessary to also invert the position of the ejection port cover located on the opposite side of the extractor.

- To ease the procedure of inverting the position of the controls, it is advisable to also remove the spring/spring guide assembly (**Fig. 30**).
- Using a drift-punch or similar, gently push the cover from the open side of the ejection port (**Fig. 31**) until the cover is completely removed.

WARNING: The cover MUST always be mounted on the opposite side of the extractor in order to avoid possible mis-ejection of the case.





- To remount the ejection port cover on the side desired, take care to correctly insert the two upper protrusions of the cover in their respective recesses on the bolt.
- Mount the extractor on the opposite side paying attention to insert its rear protrusion into the seat of the bolt (**Fig. 32**).
- Insert the ejector on the opposite side to the extractor as shown in **Fig. 33**.
- Remount the spring/spring guide assembly if previously disassembled.
- Push the retaining spring clip down into its seat (**Fig. 34**).
- Once the bolt is reassembled onto the barrel line up the hole found on the bolt body with the rear part of the cocking port (circular part) (**Fig. 12**) and insert the cocking handle (with the concave part facing the barrel) into the seat pushing it into the hole (right or left side) of the bolt.
- Proceed with the rest of the reassembly as indicated in the dedicated chapter.

MANUAL SAFETY BUTTON, MAGAZINE RELEASE BUTTON

The above mentioned controls can be reversed from one side of the carbine to the other for right or left hand use.



WARNING: Please contact a qualified gunsmith to reverse the manual safety and the magazine release buttons.



WARNING: Do not attempt to alter the internal parts of your carbine's firing mechanism. Alterations to the hammer, trigger, springs, sear or other internal parts can result in a very dangerous situation.



WARNING: Altering the internal parts of your carbine's firing mechanism voids the manufacturer's warranty.

MAINTENANCE

The firearm should be cleaned as soon as possible after firing. Use only high-quality, commercially-available firearm cleaning solvents and cleaning equipment.

WARNING: Never store a loaded firearm.

WARNING: The firearm should not be disassembled for cleaning beyond what is described below. Only a qualified gunsmith who is familiar with these firearms should conduct further disassembly.

WARNING: Do not attempt to alter the internal parts of your carbine's firing mechanism. Alterations to the hammer, trigger, springs, sear or other internal parts can result in a very dangerous situation.

WARNING: Altering the internal parts of your carbine's firing mechanism voids the manufacturer's warranty.

WARNING: Do not attempt to make repairs to any firearm without proper knowledge or training. Do not alter parts or use substitute parts not made by Beretta. Any alterations or adjustments that may be necessary to the operating mechanism should be performed by the Manufacturer or by its Local Official Distributor.

DISASSEMBLY

WARNING: Always be certain that the carbine is unloaded. Please refer to the instructions given in the "Load check" paragraph.

Notice: It is advisable to carry out the field stripping and the assembly operations over a table to catch components should they drop.

CAUTION: before disassembling the parts, carefully observe and memorize the position of the components to facilitate their correct reassembly.

To disassemble the carbine, please refer to the instructions given in the disassembly paragraph in the "obstruction check" section.





CLEANING



WARNING: Excess oil and grease obstructing the bore, even partially, is very dangerous when firing and may cause barrel rupture and serious injury to the shooter and bystanders. Never spray or apply oil to the cartridges. Use lubricants properly. You are responsible for the proper care and maintenance of your firearm.

BARREL

- Spray a brush with Beretta oil or a good grade gun oil. Insert the brush into the barrel by means of a rod from the chamber and scrub the chamber and bore thoroughly. If necessary, first clean the bore with a gun solvent.
- Dry the chamber and bore by pushing a cotton patch through the chamber and bore with the rod. Change the patch until it emerges clean.



WARNING: Check the barrel to be sure there are no obstructions in the chamber and bore.

- Lightly oil the inside of the barrel by passing through it a clean cotton patch soaked in Beretta oil or a good grade gun oil.
- Lightly oil the outside of the barrel.

BOLT

- Clean the bolt with a patch and Beretta oil or a good grade gun oil, paying special attention to the breech face, extractor, ejector and to the bolt guides. If necessary, use the brush. Wipe bolt surfaces with a clean patch.
- Lightly oil the bolt.

RECOIL SPRING AND SPRING GUIDE

- Lightly oil the recoil spring and spring guide with Beretta oil or a good grade gun oil. After long use it could be necessary to first scour these parts using a brush.

RECEIVER AND STOCK

- Using a synthetic wire brush clean all areas covered by gunpowder residue and dirt.
- Wipe outer receiver and stock surfaces clean and lightly lubricate the rails and moving parts. Lightly oil the disassembly latch, magazine catch, travel slide stop, trigger system, hammer and the levers between the hammer and the trigger system (**Fig. 35 - see arrows**).

CAUTION: Do not apply excess oil.

MAGAZINE

- Make sure the magazine is thoroughly clean and the follower slides easily downward if pressed.
- If necessary, lightly oil with Beretta oil or a good grade gun oil the internal walls of the magazine box.
- Run a dry patch through the box. Do not leave lubricant inside the magazine box.

CAUTION: Do not apply excess oil. Accumulation of oil attracts dirt and dust, which can interfere with the functioning and reliability of the firearm.

REASSEMBLY

To reassemble the carbine, please refer to the instructions given in the reassembly paragraph in the “obstruction check” section.



STORAGE



WARNING: The carbine should be stored UNLOADED, with the bolt in closed position, the safety engaged and the hammer decocked (to decock the hammer pull the trigger).



WARNING: Store firearms and ammunition separately, each in its own locked container, and away from children and unauthorized adults!



WARNING: Be certain your firearm is unloaded before shipping or taking it to the dealer.

CAUTION: It is recommended to store the firearm in the supplied case. Before storage, always check the conditions of the carbine and its case. Make sure that they are perfectly dry.

CAUTION: Do not store your carbine in a leather, fabric or canvas holster or case. These materials attract moisture, even though they may appear to be perfectly dry.

Fig. 21



Fig. 22

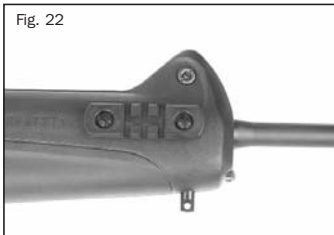

Fig. 23

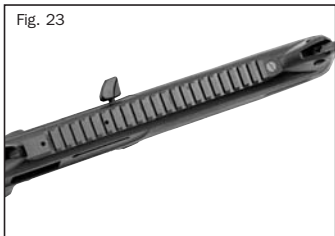

Fig. 24



Fig. 25



Fig. 26

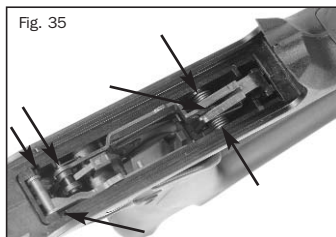
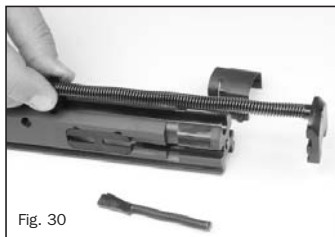

Fig. 27



Fig. 28





Le illustrazioni e descrizioni di questo opuscolo si intendono fornite a titolo indicativo. La Casa si riserva pertanto il diritto di apportare ai suoi modelli, in qualsiasi momento e senza preavviso, quelle modifiche che ritenesse utili per migliorarli o per qualsiasi esigenza di carattere costruttivo e commerciale.

The illustrations and descriptions given in this brochure are intended as a general guide only, and must not be taken as binding. The Company, therefore, reserves the right to make, at any moment and without prior notice, any changes it thinks necessary to improve its models or to meet any requirements of manufacturing or commercial nature.

Les illustrations et les descriptions contenues dans ce prospectus ne sont données qu'à titre indicatif. La Maison se réserve le droit de modifier, à tout moment et sans préavis, ses modèles pour les améliorer ou pour n'importe quelle exigence de caractère constructif et commercial.

Las ilustraciones y descripciones de este folleto tienen un valor puramente indicativo. La Casa se reserva por lo tanto el derecho de aportar a sus modelos, en todo momento y sin previo aviso, cuantas modificaciones considere útiles al fin de mejorarlos o por cualquier exigencia de construcción o de oportunidad comercial.

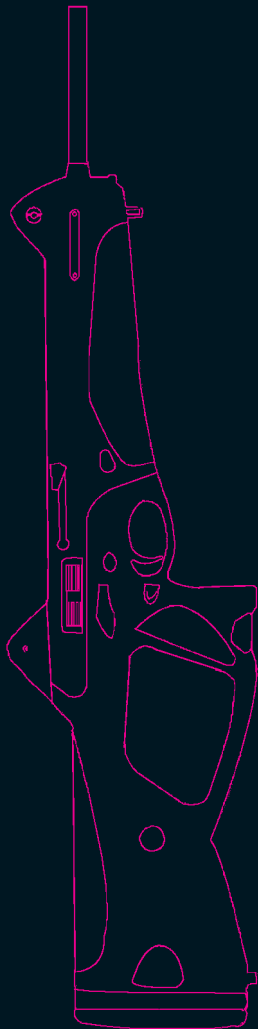

BERETTA

Fabbrica d'Armi
Pietro Beretta S.p.A.
Via Pietro Beretta, 18
25063 GARDONE V.T.
(Brescia) Italia
Tel. (030) 8341.1
www.beretta.com

